



Buy it for looks. Buy it for life.®

Specifications

DESCRIPTION

- Single function spray with various finishes identified by suffix
- Immersion technology

OPERATION

- Spray face tilts 20 degrees in any direction

FLOW

- Designed to deliver 2.0 gpm max (7.6 L/min) at 80 psi

STANDARDS

- Third party certified to ASME A112.18.1/ CSA B125.1, and all applicable requirements referenced therein

WARRANTY

- Lifetime limited warranty against leaks and finish defects to the original consumer purchaser
- 5 year warranty if used in commercial installations

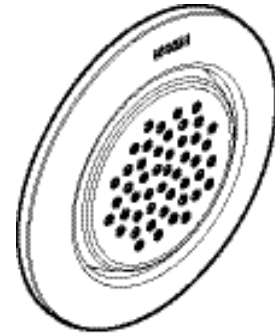

Single Function Body Spray

Models: TS1322 series

Rough-In: S1300

1" Extension Kit: 155656
(available separately)

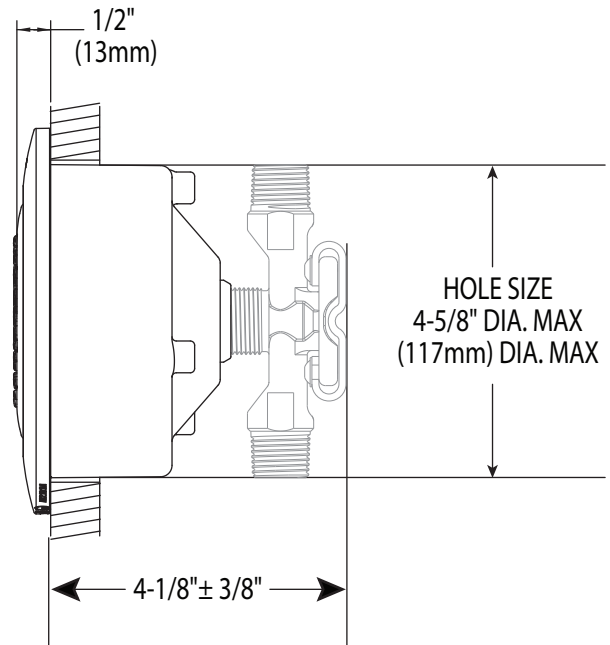
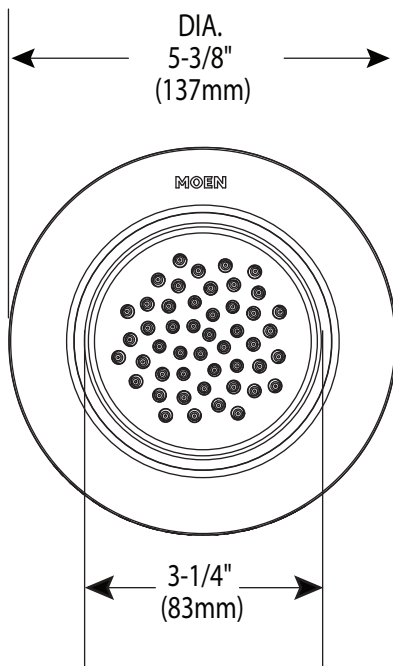

CRITICAL DIMENSIONS

(DO NOT SCALE)