

36"

Item Number:
157-V36-BW
157-V36-SBR
157-V36-VV
157-V36-WW

JAMES MARTIN



VANITIES™

Bristol 36" Single Vanity Cabinet
Diagrams with Dimensions
page 01 of 03

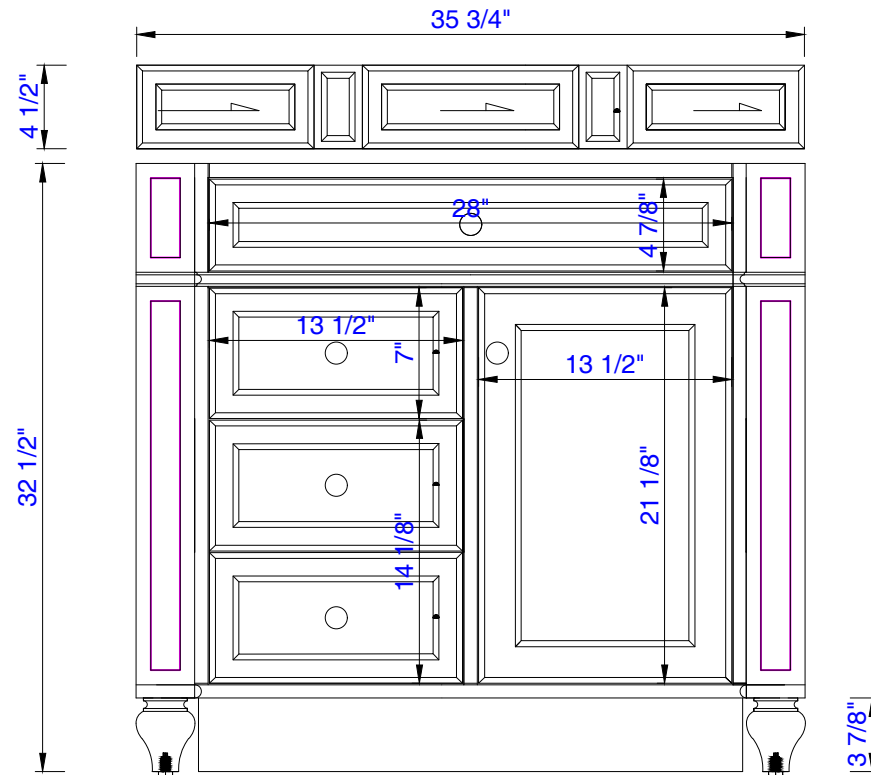

NOTE ONE: Countertops are not shown in these diagrams .(Cabinet Only)

NOTE TWO: Wood Backsplash (Shown) is designed for the molding detail to align with sinks in James Martin's Optional Countertops.
Customers' own countertops and sinks may align differently.

Please consult our website for Countertop Diagrams: www.jamesmartinvanities.com

Version:202107

36"

Item Number:
157-V36-BW
157-V36-SBR
157-V36-VV
157-V36-WW

JAMES MARTIN

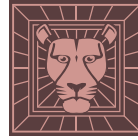

VANITIES™

Bristol 36" Single Vanity Cabinet
Diagrams with Dimensions
page 02 of 03

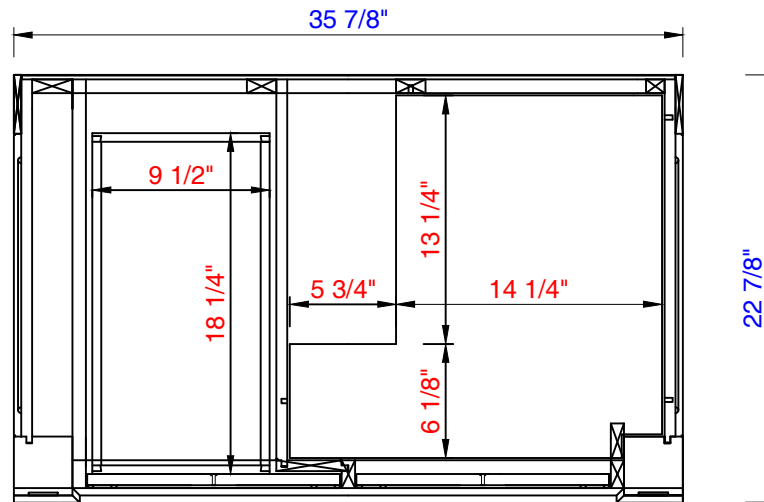
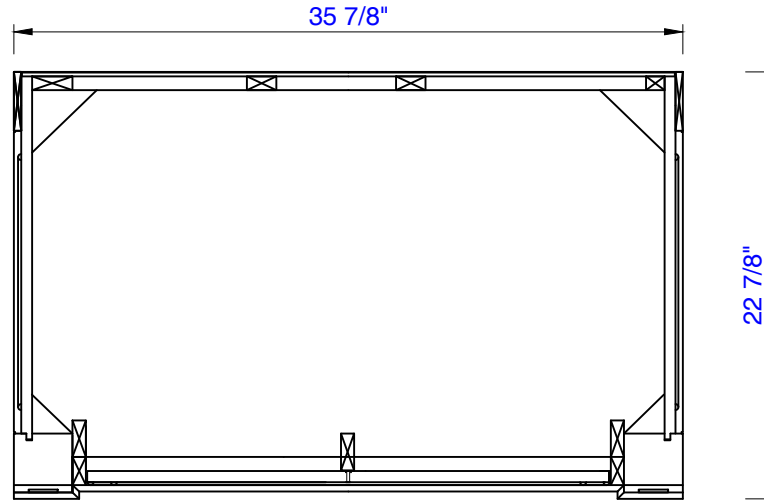

NOTE ONE: Countertops are not shown in these diagrams .(Cabinet Only)

NOTE TWO: Internal Shelves (Shown) are designed to align with sinks in James Martin's Optional Countertops.
Customers' own countertops and sinks may align differently, and modification may be required.
Please consult our website for Countertop Diagrams: www.jamesmartinvanities.com

36"

Item Number:
157-V36-BW
157-V36-SBR
157-V36-VV
157-V36-WW

JAMES MARTIN

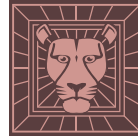

VANITIES™

Bristol 36" Single Vanity Cabinet

Diagrams with Dimensions

page 03 of 03

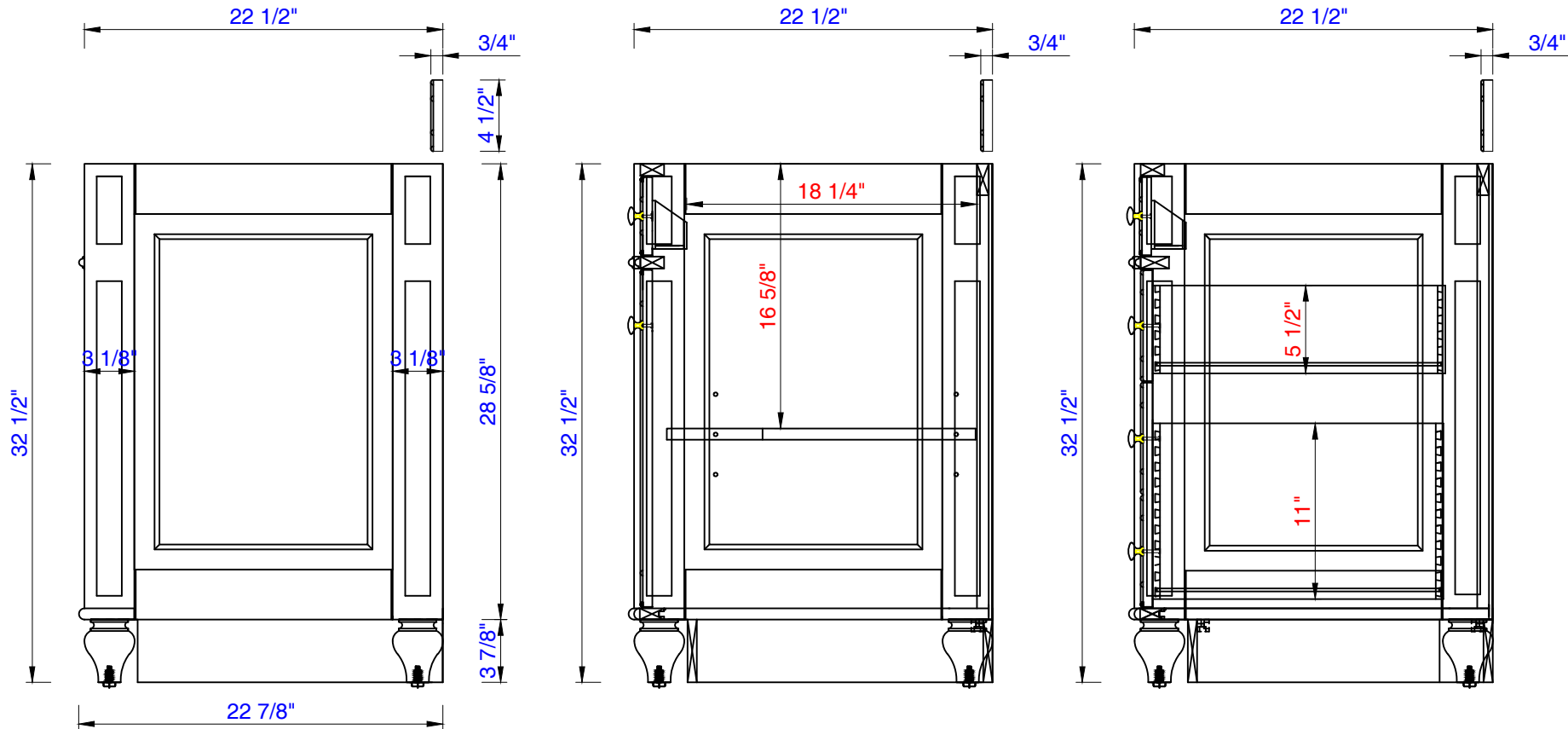

NOTE ONE: Countertops are not shown in these diagrams .(Cabinet Only)

NOTE TWO: Wood Backsplash (Shown) is designed for the molding detail to align with sinks in James Martin's Optional Countertops.

Customers' own countertops and sinks may align differently.

Please consult our website for Countertop Diagrams: www.jamesmartinvanities.com

Version:202107

914mm

Item Number:
157-V36-BW
157-V36-SBR
157-V36-VV
157-V36-WW

JAMES MARTIN

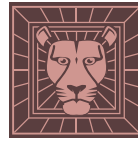

VANITIES™

Bristol 914mm Single Vanity Cabinet

Diagrams with Dimensions

page 01 of 03

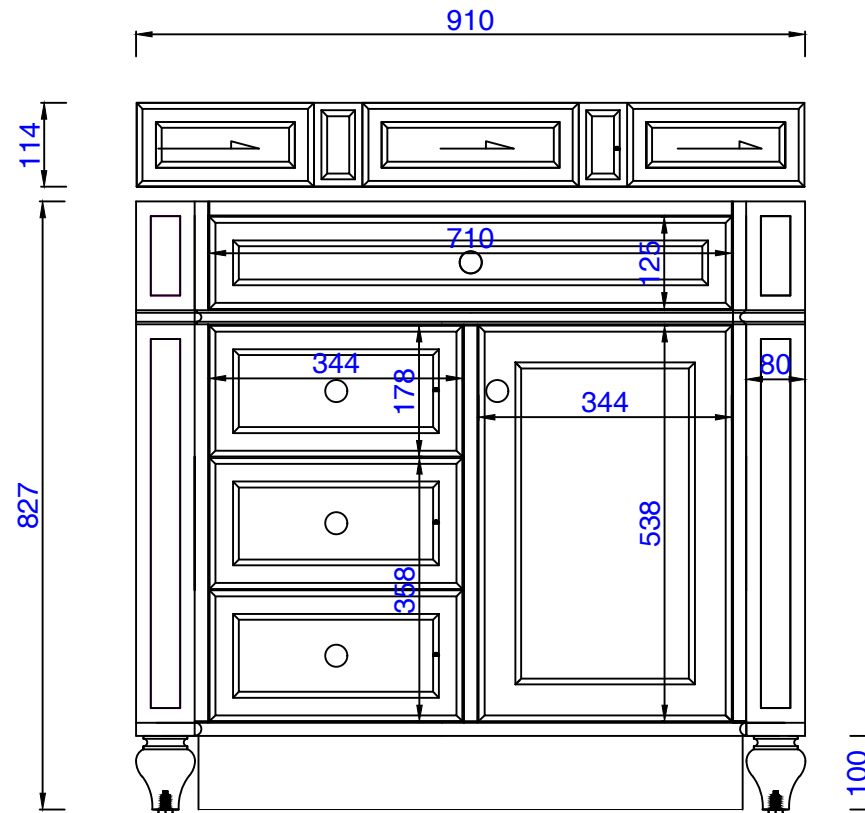

NOTE ONE: Countertops are not shown in these diagrams .(Cabinet Only)

NOTE TWO: Wood Backsplash (Shown) is designed for the molding detail to align with sinks in James Martin's Optional Countertops.

Customers' own countertops and sinks may align differently.

Please consult our website for Countertop Diagrams: www.jamesmartinvanities.com

Version:202107

914mm

Item Number:
157-V36-BW
157-V36-SBR
157-V36-VV
157-V36-WW

JAMES MARTIN

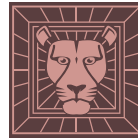

VANITIES™

Bristol 914mm Single Vanity Cabinet

Diagrams with Dimensions

page 02 of 03

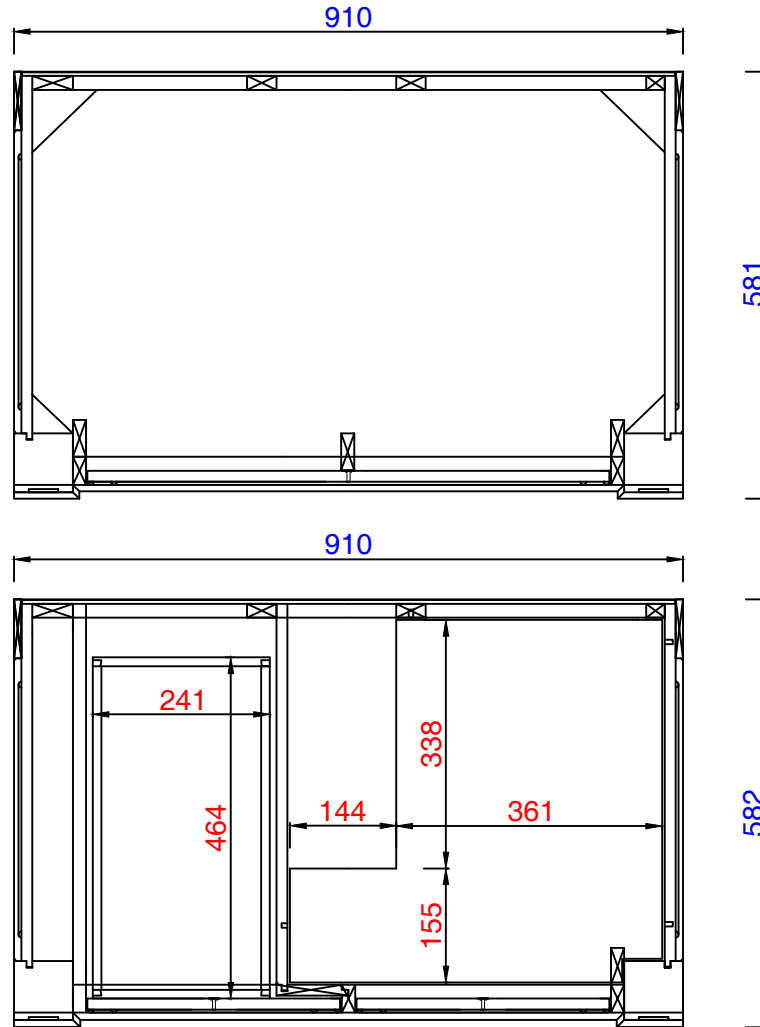

NOTE ONE: Countertops are not shown in these diagrams .(Cabinet Only)

NOTE TWO: Internal Shelves (Shown) are designed to align with sinks in James Martin's Optional Countertops.
Customers' own countertops and sinks may align differently, and modification may be required.
Please consult our website for Countertop Diagrams: www.jamesmartinvanities.com

Version:202107

914mm

Item Number:
157-V36-BW
157-V36-SBR
157-V36-VV
157-V36-WW

JAMES MARTIN



VANITIES™

Bristol 914mm Single Vanity Cabinet

Diagrams with Dimensions

page 03 of 03

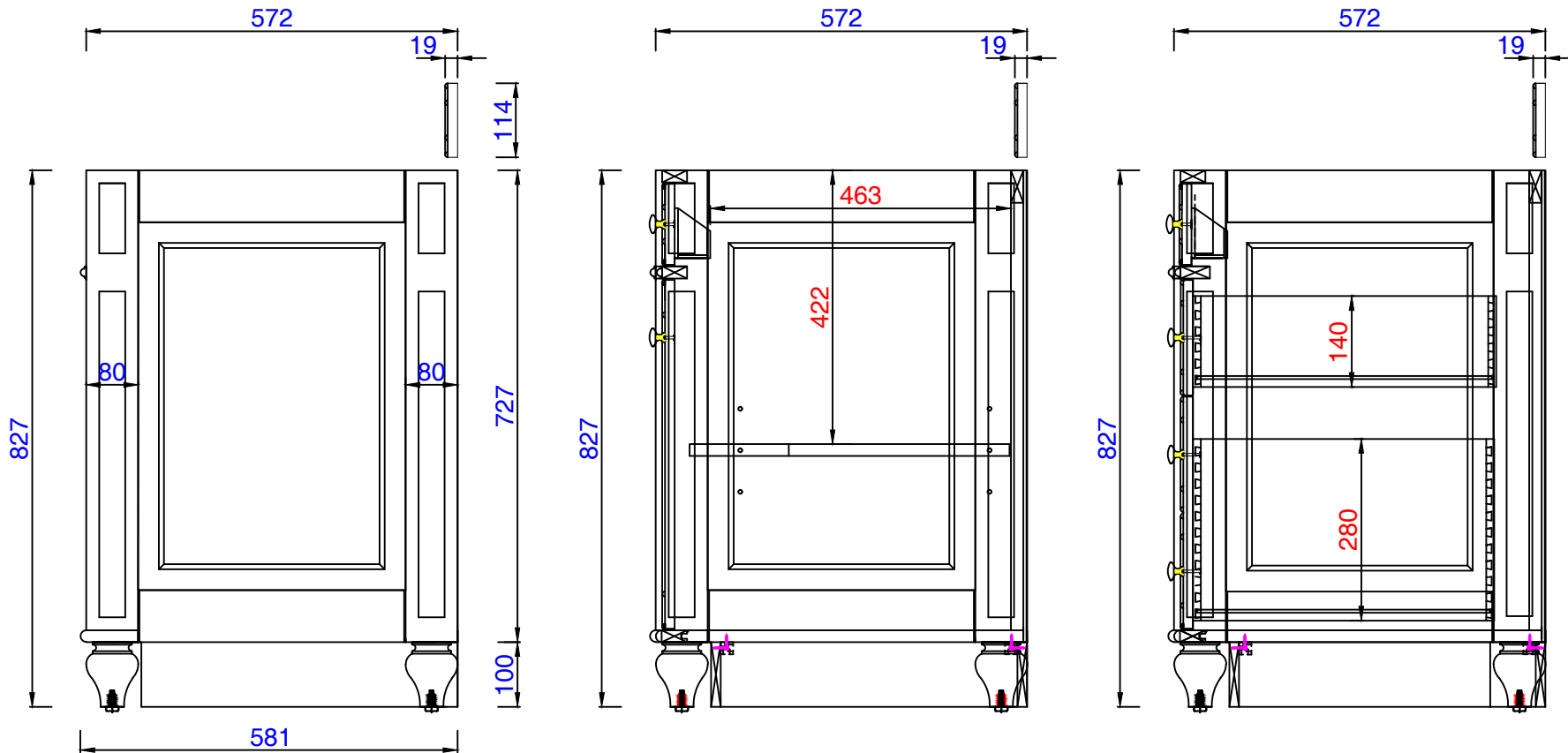

NOTE ONE: Countertops are not shown in these diagrams .(Cabinet Only)

NOTE TWO: Wood Backsplash (Shown) is designed for the molding detail to align with sinks in James Martin's Optional Countertops.

Customers' own countertops and sinks may align differently.

Please consult our website for Countertop Diagrams: www.jamesmartinvanities.com

Version:202107