

32" H61 Reeded with End Caps Front Mount Shower Door Pull

Model #: H61-FM-32-

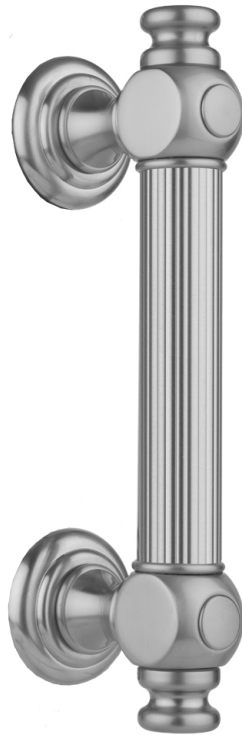

FEATURES:

- Can be mounted vertically or horizontally
- Can be used as a towel bar, foot rest, or shaving station when mounted horizontally
- Not to be used as a grab bar
- All brass construction, full polished & plated
- For Glass Installation: Separate mounting kit required (HDL-GLSKIT)
- Custom sizes available- Contact JACLO for pricing & availability

AVAILABLE FINISHES:

Polished Chrome (PCH)	Satin Chrome (SC)	Bronze Umber (BU)
Satin Nickel (SN)	Pewter (PEW)	Caramel Bronze (CB)
Polished Nickel (PN)	Antique Brass (AB)	Antique Copper (ACU)
Oil-Rubbed Bronze (ORB)	Polished Brass (PB)	Polished Copper (PCU)
Vintage Bronze (VB)	Satin Brass (SB)	Rose Gold (RG)
Matte Black (MBK)	Satin Gold (SG)	Polished Gold (PG)
Black Nickel (BKN)	Bombay Gold (BG)	Jewelers Gold (JG)
Europa Bronze (EB)	White (WH)	Sedona Beige (SDB)
Tristan Brass (TB)	Unlacquered Brass (ULB)	Satin Cooper (SCU)

SPECIFICATION DRAWING:

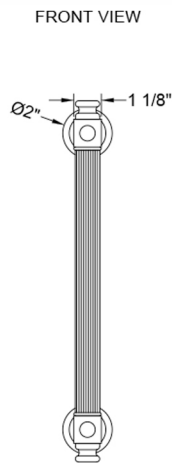
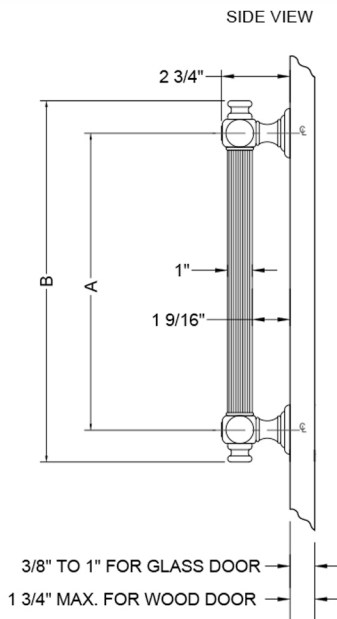

BRASS LUXURY FRONT MOUNT DOOR PULL			
PART. #	DESCRIPTION	A	B
H61-FM-	6" CENTER TO CENTER	6"	8 5/8"
H61-FM-8	8" CENTER TO CENTER	8"	10 5/8"
H61-FM-12	12" CENTER TO CENTER	12"	14 5/8"
H61-FM-16	16" CENTER TO CENTER	16"	18 5/8"
H61-FM-18	18" CENTER TO CENTER	18"	20 5/8"
H61-FM-24	24" CENTER TO CENTER	24"	26 5/8"
H61-FM-32	32" CENTER TO CENTER	32"	34 5/8"