

KTI42XT

42" T-SHAPE ISLAND HOOD
STAINLESS STEEL



Complete your Bertazzoni kitchen with this elegant island ventilation solution

Choose among 4 extraction airflow speeds, reaching a maximum flow performance of 600 CFM (cubic feet per minute).

Easily throttle down airflow to 295 or 395 CFM with the digital airflow reducer

Enjoy the ultra-quiet performance rated at 2.5 sones (lowest setting)

Easily control all hood functions with the electronic controls or the included ADA-compliant remote control.

Enjoy powerful illumination of the cooking surface with 4 long-lasting and bright LED lights, which also don't create additional heat and are energy efficient.

Filter out odors and grease with the elegant yet practical European baffle filters, which can be easily cleaned periodically in the dishwasher.

The hood comes standard for venting outside the kitchen, but can be easily modified for recirculation by installing the optional charcoal filters.

Duct cover extension available for installation in kitchens with tall ceiling.

Designed and manufactured with pride in Italy.

Industry leading 2 years parts and labor warranty.

PRODUCT FEATURES

Size	42"
Hood type	Island mount
Hood finish	Stainless steel
Motor	1
Speed	3 + Booster
Hood control	Electronic with buttons
Remote control	Included
Lights	4 LED
Filters type	Stainless steel mesh
Extraction power	600 CFM
Sound Level (min)	2.5 Sones
Recirculation	Yes
Duct cover	Included
Duct size	6" diameter

TECHNICAL SPECIFICATIONS

Electrical supply	110-120 V 60 HZ - 394 W WIRING BOX Amp
Power connection	Hardwired
Certification	ADA Compliant, CEC, UL
Warranty	2 years parts & labor
Packaging dimensions and weight	W 51 15/16" H 19 15/16" D 31 8/16" 99.87 lbs

OPTIONAL ACCESSORIES

901581	Baffle filter kit for Island Hood
901585	Duct cover installation up to 10' for Island Hood
901531	Charcoal filters
901532	Durable charcoal filters

KTI42XT

42" T-SHAPE ISLAND HOOD
STAINLESS STEEL



PRODUCT DIMENSIONS

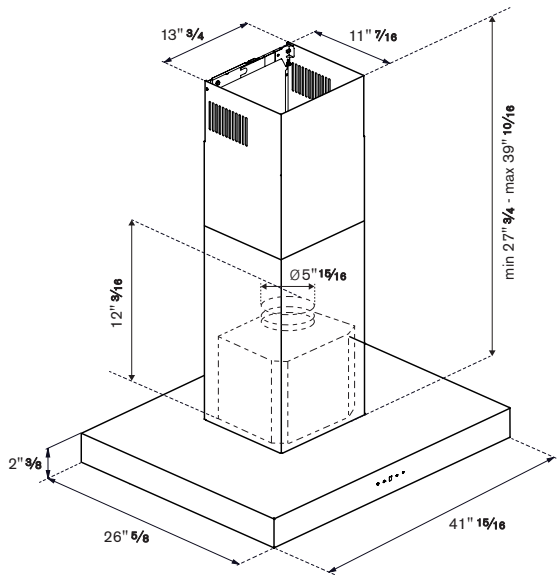

SIDE VIEW

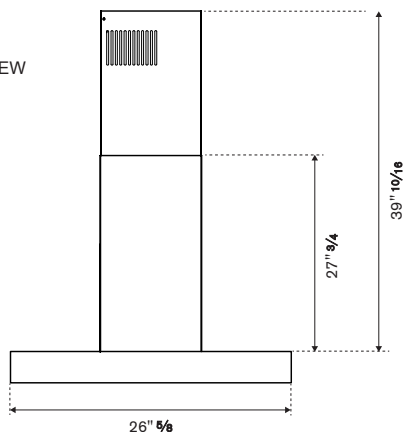

PRODUCT INSTALLATION

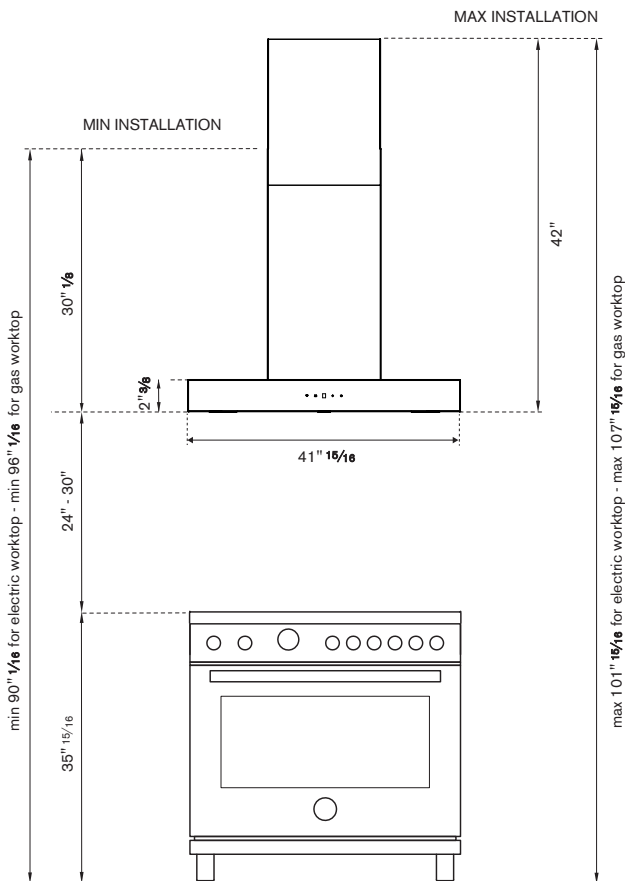

Hood Clearance

Recommended height above cooking surface:
min 24" for electric worktop
min 30" for gas worktop

INSTALLATION OF WIRING CONNECTION

Remove the cover from the field wiring compartment.
DO NOT turn on the power until installation is complete!
Connect the Power Supply Cable to the rangehood.
Connect the Green (Green and Yellow) ground wire
under the Green grounding screw.

Attach the White lead of the power supply to the White lead of the
rangehood with a twist-on type wire connector.
Attach the Black lead of the power supply to the Black lead of the
rangehood with a twist-on type wire connector.
Replace the field wiring compartment cover and the grease filters.

- A. Home power supply cable
- B. Black wires
- C. UL listed wire connectors
- D. White wires
- E. Green (or bare) ground wire from home power supply connected to green ground screw
- F. Range hood power supply cable
- G. Range hood power supply cable connected to green ground screw

